

# Panasonic

WMA MP3 CD Player/Receiver  
WMA MP3 CD-плеер/ресивер  
WMA MP3 單片 CD / 收音機  
WMA MP3 CD 플레이어 / 라디오

Model: **CQ-C3305W**

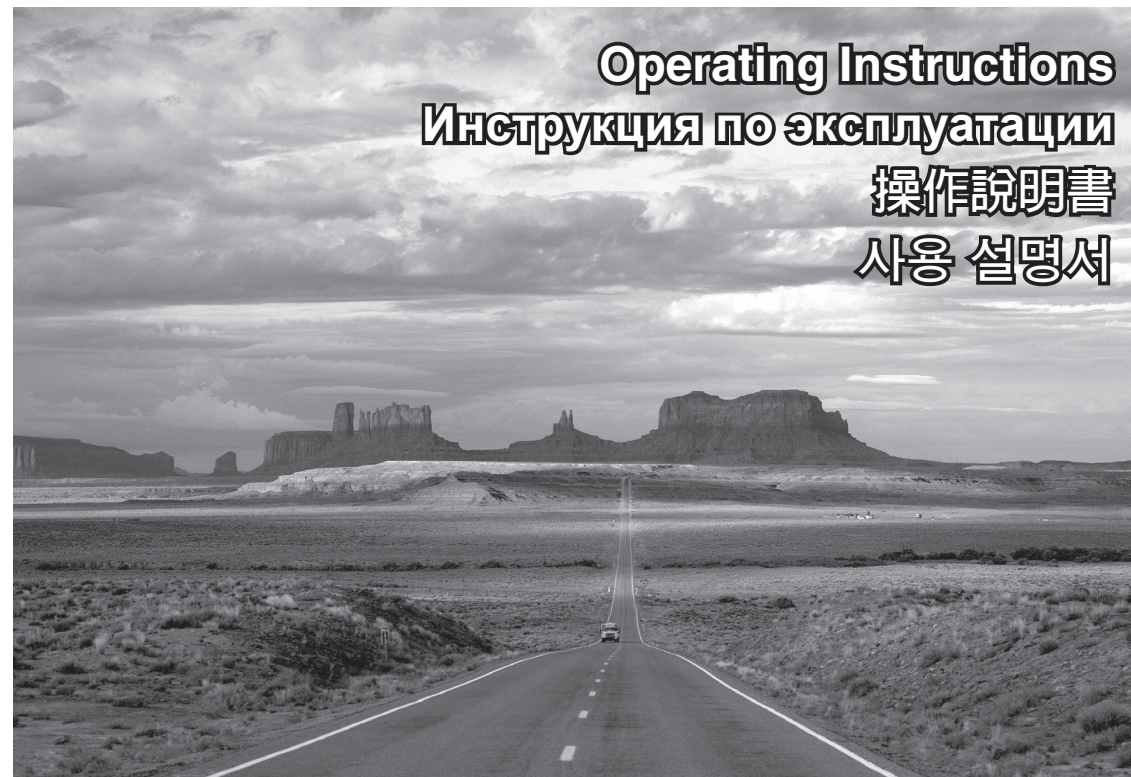

WMA

MP3

- Please read these instructions carefully before using this product and keep this manual for future reference.
- Перед использованием данного изделия внимательно прочитайте эти инструкции и сохраните их для последующего использования.
- 使用本產品之前，請仔細閱讀這些說明書，並妥善保管本操作說明書以備將來使用。
- 본 제품의 바른 사용을 위해, 이 사용설명서를 잘 읽어 주십시오.  
잘 보관하시어 필요하실 때마다 읽어주시기 바랍니다.

- Read the operating instructions for the unit and all other components of your car audio system carefully before using the system. They contain instructions about how to use the system in a safe and effective manner. Panasonic assumes no responsibility for any problems resulting from failure to observe the instructions given in this manual.

 **Warning** This pictograph intends to alert you to the presence of important operating instructions and installation instructions. Failure to heed the instructions may result in severe injury or death.

- This manual uses pictographs to show you how to use the product safely and to alert you to potential dangers resulting from improper connections and operations. The meanings of the pictographs are explained below. It is important that you fully understand the meanings of the pictographs in order to use this manual and the system properly.

 **Caution** This pictograph intends to alert you to the presence of important operating instructions and installation instructions. Failure to heed the instructions may result in injury or material damage.

 **Warning**  
Observe the following warnings when using this unit.

- The driver should neither watch the display nor operate the system while driving.**  
Watching the display or operating the system will distract the driver from looking ahead of the vehicle and can cause accidents. Always stop the vehicle in a safe location and use the parking brake before watching the display or operating the system.
- Use the proper power supply.**  
This product is designed for operation with a negative grounded 12 V DC battery system. Never operate this product with other battery systems, especially a 24 V DC battery system.
- Protect the Deck Mechanism.**  
Do not insert any foreign objects into the slot of this unit.
- Do not disassemble or modify the unit.**  
Do not disassemble, modify the unit or attempt to repair the product yourself. If the product needs to be repaired, consult your dealer or an authorized Panasonic Service Center.
- Do not use the unit when it is out of order.**  
If the unit is out of order (no power, no sound) or in an abnormal state (has foreign objects in it, is exposed to water, is smoking, or smells), turn it off immediately and consult your dealer.
- The remote control unit should not lie about in the car.**  
If the remote control unit lies about, it could fall on the floor while driving, get wedged under the brake pedal, and lead to a traffic accident.
- Refer fuse replacement to qualified service personnel.**  
When the fuse blows out, eliminate the cause and have it replaced with the fuse prescribed for this unit by a qualified service engineer. Incorrect replacement of the fuse may lead to smoke, fire, and damage to the product.

**Observe the following warnings when installing.**

- Disconnect the lead from the negative (–) battery terminal before installation.**  
Wiring and installation with the negative (–) battery terminal connected may cause electrical shock and injury due to a short circuit.  
Some cars equipped with the electrical safety system have specific procedures of battery terminal disconnection.  
**FAILURE TO FOLLOW THE PROCEDURE MAY LEAD TO THE UNINTENDED ACTIVATION OF THE ELECTRICAL SAFETY SYSTEM RESULTING IN DAMAGE TO THE VEHICLE AND PERSONAL INJURY OR DEATH.**
- Never use safety-related components for installation, grounding, and other such functions.**  
Do not use safety-related vehicle components (fuel tank, brake, suspension, steering wheel, pedals, airbag, etc.) for wiring or fixing the product or its accessories.
- Installing the product on the air bag cover or in a location where it interferes with airbag operation is prohibited.**
- Check for piping, gasoline tank, electric wiring, and other items before installing the product.**  
If you need to open a hole in the vehicle chassis to attach or wire the product, first check where the wire harness, gasoline tank, and electric wiring are located. Then open the hole from outside if possible.
- Never install the product in a location where it interferes with your field of vision.**
- Never have the power cord branched to supply other equipment with power.**
- After installation and wiring, you should check the normal operation of other electrical equipment.**  
The continuation of their using in abnormal conditions may cause fire, electrical shock or a traffic accident.
- In the case of installation to an airbag-equipping car, confirm warnings and cautions of the vehicle manufacturer before installation.**
- Make sure the leads do not interfere with driving or getting in and out of the vehicle.**
- Insulate all exposed wires to prevent short circuiting.**

 **Caution**  
Observe the following cautions when using this unit.

- Keep the sound volume at an appropriate level.**  
Keep the volume level low enough to be aware of road and traffic conditions while driving.
- This unit is designed for use exclusively in automobiles.**
- Do not operate the unit for a prolonged period with the engine turned off.**  
Operating the audio system for a long period of time with the engine turned off will drain the battery.
- Do not expose the unit to direct sunlight or excessive heat.**  
Otherwise these will raise the interior temperature of the unit, and it may lead to smoke, fire, or other damage to the unit.
- Do not use the product where it is exposed to water, moisture, or dust.**  
Exposure of the unit to water, moisture, or dust may lead to smoke, fire, or other damage to the unit. Make especially sure that the unit does not get wet in car washes or on rainy days.
- Set the volume level to low enough before the AUX connection is completed.**  
Failure to observe this, the loud noise may come out and damage your speakers and your hearing. Direct connection of the speaker/headphone output of an external device without any attenuator may distort sound or damage the connected external device.

**Observe the following cautions when installing.**

- Refer wiring and installation to qualified service personnel.**  
Installation of this unit requires special skills and experience. For maximum safety, have it installed by your dealer. Panasonic is not liable for any problems resulting from your own installation of the unit.
- Follow the instructions to install and wire the product.**  
Not following the instructions to properly install and wire the product could cause an accident or fire.
- Take care not to damage the leads.**  
When wiring, take care not to damage the leads. Prevent them from getting caught in the vehicle chassis, screws, and moving parts such as seat rails. Do not scratch, pull, bend or twist the leads. Do not run them near heat sources or place heavy objects on them. If leads must be run over sharp metal edges, protect the leads by winding them with vinyl tape or similar protection.

 **Caution**  
THIS PRODUCT IS A CLASS I LASER PRODUCT. USE OF CONTROLS OR ADJUSTMENTS OR PERFORMANCE OF PROCEDURES OTHER THAN THOSE SPECIFIED HEREIN MAY RESULT IN HAZARDOUS RADIATION EXPOSURE. DO NOT OPEN COVERS AND DO NOT REPAIR BY YOURSELF. REFER SERVICING TO QUALIFIED PERSONNEL.

- Use the designated parts and tools for installation.**  
Use the supplied or designated parts and appropriate tools to install the product. The use of parts other than those supplied or designated may result in internal damage to the unit. Faulty installation may lead to an accident, a malfunction or fire.
- Do not block the air vent or the cooling plate of the unit.**  
Blocking these parts will cause the interior of the unit to overheat and will result in fire or other damage.
- Do not install the product where it is exposed to strong vibrations or is unstable.**  
Avoid slanted or strongly curved surfaces for installation. If the installation is not stable, the unit may fall down while driving and this can lead to an accident or injury.
- Installation Angle**  
The product should be installed in a horizontal position with the front end up at a convenient angle, but not more than 30°. The user should bear in mind that in some areas there may be restrictions on how and where this unit must be installed. Consult your dealer for further details.
- Wear gloves for safety. Make sure that wiring is completed before installation.**
- To prevent damage to the unit, do not connect the power connector until the whole wiring is completed.**
- Do not connect more than one speaker to one set of speaker leads. (except for connecting to a tweeter)**

# Before Reading These Instructions

Panasonic welcomes you to our constantly growing family of electronic products owners. We endeavor to give you the advantages of precise electronic and mechanical engineering, manufactured with carefully selected components, and assembled by people who are proud of the reputation their work has built for our company. We know this product will bring you many hours of enjoyment, and after you discover the quality, value and reliability we have built into it, you too will be proud to be a member of our family.

The instruction manual consists of 2 books. One is "Operating Instructions" describing the operations of the main unit. The other is "System Upgrade Guidebook" describing the optional devices such as CD changer.

## Accessories

<b>Operating Instructions</b> (YEFM285931)	<b>System Upgrade Guidebook</b> (YEFM262786)	<b>Installation Instructions</b> (YEFM294305)	<b>Instruction kit</b> Q'ty: 1 set			<b>Power Connector</b> (YGAJ021009) Q'ty: 1
<b>Lock Cancel Plate</b>	<b>Mounting Bolt</b> (5 mm φ)	<b>Rubber Bushing</b>	<b>Mounting Collar</b> (YEFX0217263A) Q'ty: 1	<b>Trim Plate</b> (YEFC051011) Q'ty: 1	<b>Removable Face Plate Case</b> (YEFA131839A) Q'ty: 1	
(YEPOFZ5698) Q'ty: 1 set						

### Notes:

- The number in parenthesis underneath each accessory part name is the part number for maintenance and service.
- Accessories and their parts numbers are subject to modification without prior notice due to improvements.
- Mounting Collar and Trim Plate are mounted on the main unit at shipment.

# Contents

## English

Русский	28
中文	54
한국어	80

## Common

• Safety Information	2
• Before Reading These Instructions	4
• Features	6
• Controls Layout	7
• Preparation (Clock Adjustment etc.)	8
• General	9
• Sound Control	11

## Each Source

• Radio	12
• CD Player	14
• MP3/WMA Player	16

## As Needed

• Audio Setting	20
• Function Setting	21
• Troubleshooting	22
• Error Display Messages	25
• Notes on Discs	26
• Maintenance/Fuse	26
• Specifications	27

## Hands-Free Phone System

Connection of the optional Hands-Free Phone System (Hands-Free Kit featuring *Bluetooth*® technology: CY-BT100N) allows users to talk on a handsfree cellular phone if the phone supports Bluetooth.

**Note:** This unit is designed only for receiving calls. It cannot send calls.

### Bluetooth®

The Bluetooth word mark and logo are owned by the Bluetooth SIG, Inc. and any use of such marks by Matsushita Electric Industrial Co., Ltd. is under license. Other trademarks and trade name are those of their respective owners.

## Expansion Module (Hub Unit)

Connection of the Expansion Module (hub unit, CY-EM100N) allows users to connect up to 4 optional devices shown below.

## Wide Array of Components for System Upgrade

Various optional components allow users to obtain availability of wide range of system upgrade. Upgrading the system delivers relaxed AV space in a car. For further information, refer to the separate **System Upgrade Guidebook**.

### • CD Changer

The optional adapter (Conversion Cable for DVD/CD Changer: CA-CC30N) allows you to connect the optional Panasonic CD changer unit (CX-DP880N).

### • iPod

The optional adapter (Direct Cable for iPod: CA-DC300N) allows you to connect the optional iPod series. iPod is a trademark of Apple Computer, Inc., registered in the U.S.A. and other countries.

### • Hands-Free Phone System

## SQ (Sound Quality)

SQ is a function that can call up various sound types at the touch of button in accordance with your listening music type.

## AUX (AUX1) Input Terminal

The AUX input terminal is equipped on the front panel. Your mobile audio player and other devices are connectable to this unit without any difficulty.

**Note:** This instruction manual explains operations for use with the buttons on the main unit. (Different operations excluded)

Main Unit

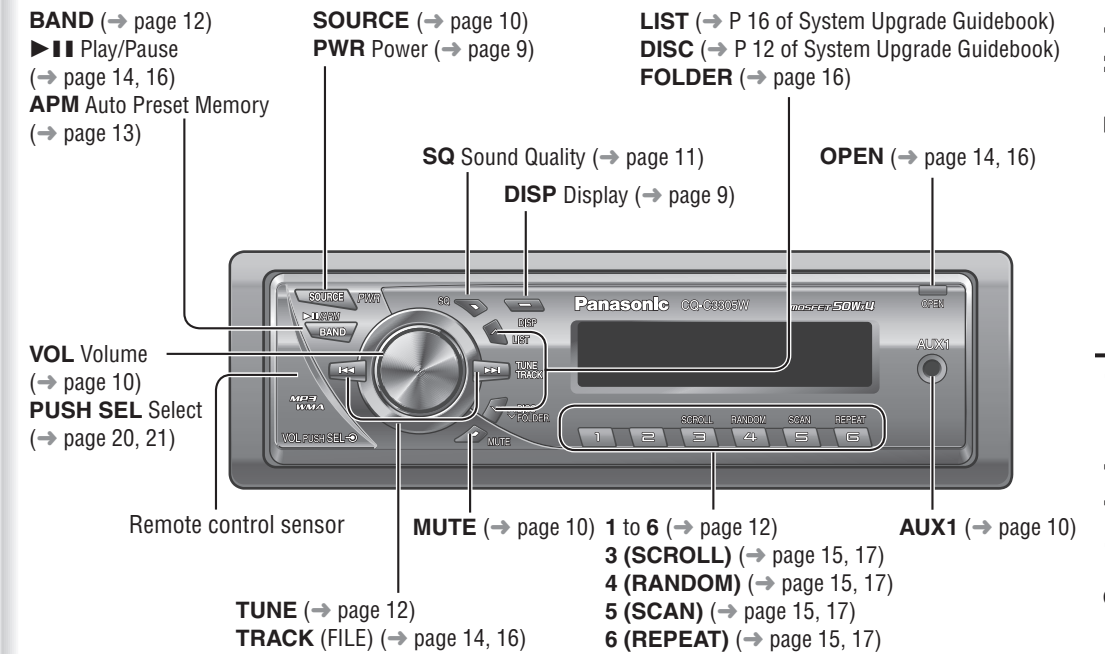



### Notes:

- Remote Control Unit for CQ-C3305W is option (CA-RC80N).
- The optional remote control is available from your local dealer. (CA-RC80N)

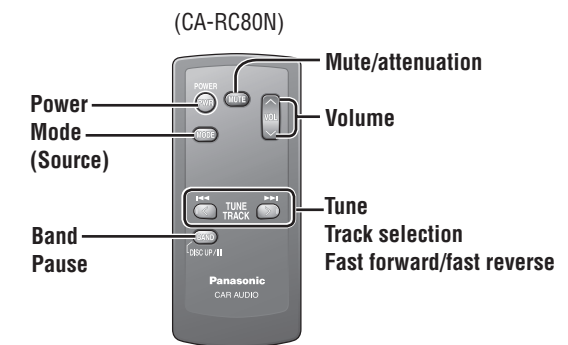
Remote Control Unit (Option)



The demonstration message appears for initial use.

- 1 Set your car's ignition switch to the ACC or ON position.  

- 2 Press [PWR] (Power).
- 3 Hold down [VOL] (PUSH SEL: Select) for 2 sec. or more to open the menu.  

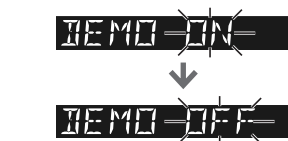
- 4 Press [VOL] (PUSH SEL: Select) to select the Demonstration setting.  
("DEMO" is displayed)  



- 5 Turn [VOL] counterclockwise.



**Notes:**

- To return to the regular mode, press [DISP].
- Refer to the section on "Function Setting" (→ page 21).
- When "NO DISC" is displayed, the Demonstration cannot be cancelled.

The 24-hour system is used for the clock.

- 1 Press [PWR] (Power).
- 2 Press [DISP].
- 3 Hold down [DISP] for 2 sec. or more.
- 4 Adjust the hour and press [DISP].  
[▶▶]: Forward  
[◀◀]: Backward  

- 5 Adjust the minute and press [DISP] to confirm the adjustment.

[▶▶]: Forward  
[◀◀]: Backward

**Notes:**

- Adjust the clock when "ADJUST" appears on the display.
- Hold down [▶▶] or [◀◀] to change numbers rapidly.
- When "NO DISC" is displayed, the clock cannot be adjusted.

This chapter explains how to turn on or off the power, how to adjust the volume, etc.

### Power on

Press [PWR] (Power).

### Power off

Hold down [PWR] (Power) for 1 sec. or more.



You can remove the face plate to prevent it from being stolen.



### Removing

- 1 Turn off the power. (→ above)
- 2 Press [OPEN]. The face plate will be opened.
- 3 Push the face plate to the left.
- 4 Pull it out toward you.
- 5 Put the face plate in the case.

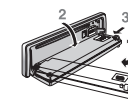

### Mounting

- 1 Fit the face plate with its left hole on the left pin provided on the main unit.
- 2 Fit the other hole on the other pin applying slight pressure.

### ⚠ Cautions

- This face plate is not waterproof. Do not expose it to water or excessive moisture.
- Do not remove the face plate while driving your car.
- Do not place the face plate on the dashboard or nearby areas where the temperature rises to high.

- Do not touch the contacts on the face plate or on the main unit, since this may result in poor electrical contacts.
- If dirt or other foreign substances get on the contacts, wipe them off with clean and dry cloth.
- To avoid damaging the face plate, do not push it down or place objects on it while it is open.

The display changes as follows every time [DISP] is pressed.

### At power-off:

 Clock display (Default)



 Display off

### At power-on:

When the power is set to ON, refer to the description for each source mode.

Volume Adjustment (VOLUME)

- ① Up
  - ② Down
- Setting Range: 0 to 40  
Default: 18

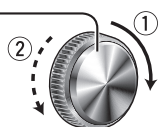

**Note:** The volume level can be set independently for each source. (For radio, one volume setting for AM, one volume setting for all FM's)



Temporary Volume Off (Down) (ATT: Attenuation)

Volume off (down)

Press [MUTE].  
MUTE



Cancel

Press [MUTE] again.  
**Note:** You can select mute or attenuation. (→ page 21)

**Caution**  
• Set the volume level to low enough before the AUX connection is completed. Failure to observe this, the loud noise may come out and damage your speakers and your hearing.

Source Selection (SOURCE)

The source changes as follows every time [SOURCE] is pressed.



**AUX1** (AUX1 in) (3.5 mm φ stereo)  
From line output of external sound/audio device (ex. Silicon-audio player, HDD player, etc.)

Radio

FM1, FM2, FM3, AM (→ page 12)  
RADIO

Player

When loading CD (→ page 14)  
CD  
When loading MP3/WMA disc (→ page 16)  
MP3/WMA

AUX1

Device connected to the AUX1 terminal of this unit  
AUX 1

System-up Connector

**When an optional device is connected:**  
Shift to connected device  
When connecting CD changer

CHANGER  
When connecting iPod  
IPOD

OR

**When an expansion module is connected:**  
The devices connected to the ports 1 to 4 are activated in sequence after shifting to AUX2 (device connected to the AUX terminal of the expansion module).

**Note:** For information about connectable devices, refer to the **System Upgrade Guidebook** or the instruction manual for each device.

SQ Selection Based on Genre (SQ (Sound Quality))

The equalizer curve is selectable from among 4 types (FLAT, ROCK, POP and VOCAL) depending on your listening category.

SQ changeover

The SQ category is changed every time [SQ] (Sound Quality) is pressed.

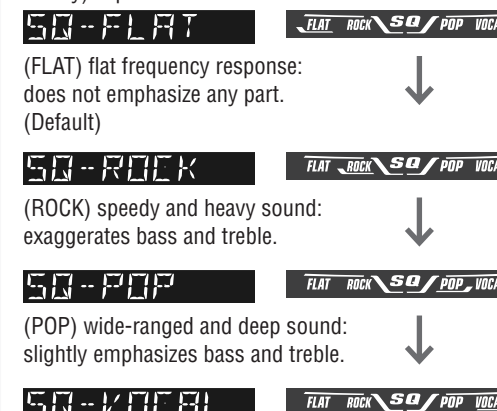

(FLAT) flat frequency response: does not emphasize any part. (Default)  
(ROCK) speedy and heavy sound: exaggerates bass and treble.  
(POP) wide-ranged and deep sound: slightly emphasizes bass and treble.  
(VOCAL) clear sound: emphasizes middle tone and slightly emphasizes treble.

Press [DISP] to return to the regular mode.

Notes:

- Setting of SQ, bass/treble and volume are influenced one another. If such an influence mentioned above causes distortion to the audio signal, readjust bass/treble or volume. (→ page 20)
- Please refer to page 20 for the adjustment to each speaker.
  - Bass adjustment
  - Treble adjustment
  - Balance adjustment
  - Fader adjustment



This chapter explains how to listen to the radio.

1 Press **[SOURCE]** to select the radio mode.

2 Press **[BAND]** to select a band.

FM1 → FM2 → FM3 → AM

3 Select a station.

### Frequency Adjustment

**[▶▶]** (TUNE): Higher

**[◀◀]** (TUNE): Lower

**Note:** Hold down for 0.5 sec. or more and release for station search.

### Preset Station Selection

Press the numeric button **[1]** to **[6]**.

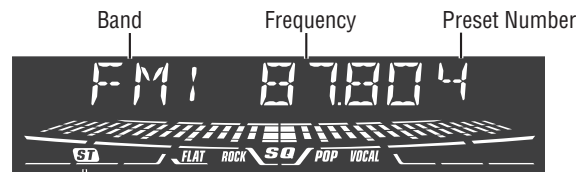

Lights while receiving an FM stereo signal.

Press **[DISP]**.

→ FM1 87.80 Frequency

↓ FM1 9:00 Clock time

↓ [ ] Display Off



Up to 6 stations can be preset in AM, FM1, FM2, and FM3 respectively.

### Auto Preset Memory (APM)

Stations with good receiving conditions automatically preset.

1 Select a band.

2 Hold down **[BAND] (APM)** for 2 sec. or more.

The preset stations under best receiving conditions are received for 5 sec. each after presetting the stations (SCAN). To stop scanning, press the numeric button **[1]** to **[6]**.

FM1 87.804

**Note:** New stations overwrite existing saved stations.

### Manual Station Preset

1 Tune in to a station.

2 Hold down the numeric button **[1]** to **[6]** for 2 sec. or more.

FM1 87.804



## ⚠ Cautions

- This unit does not support 8 cm discs.
- Do not insert a disc when **DISC** indicator lights because a disc is already loaded.
- Do not use irregularly shaped discs. (→ page 26)
- Do not use discs that have a seal or label attached.
- To avoid damaging the face plate, do not push it down or

- place objects on it while it is open.
- Do not pinch your finger or hand in the face plate.
- Do not insert foreign matter into the disc slots.
- Refer to the section on "Notes on CD/CD Media (CD-ROM, CD-R, CD-RW)" (→ page 26).
- A disc which has both CD-DA data and MP3/WMA data on it may not be reproduced normally.

When a disc is already loaded, press **[SOURCE]** to select the CD mode.

**1** Press **[OPEN]** to open the face plate.

**2** Load a disc with the printed side facing up.

**Note:** It may take some time to start playing.

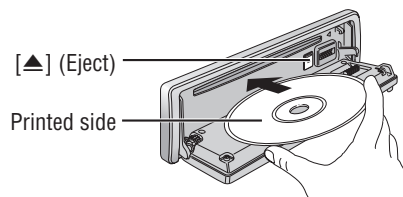

**3** Close the face plate manually.

### Notes:

- The unit recognizes the disc and starts playing automatically.
- The power will be turned on automatically when a disc is loaded.

### Disc Eject

- 1 Press **[OPEN]**.
- 2 Press **[▲]** and take the disc out.
- 3 Close the face plate manually.



**4** Select a desired portion.

### Track Selection

- [▶▶]** (TRACK): Next track
  - [◀◀]** (TRACK): Preceding track (press twice)
- Note:** Hold down for fast forward/reverse.

### Pause

- Press **[▶||]**.
- Press again to cancel.

**Play Mode indicators**  
Lights when each mode is activated.

- [R▶]** Random play
- [REP]** Repeat play

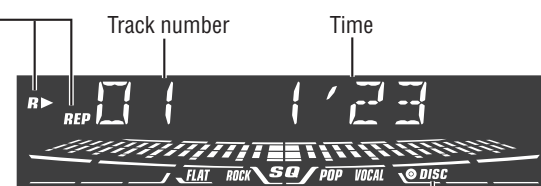

Lights when the disc is loaded.

Display Change  
(DISP: Display)

Press **[DISP]**.

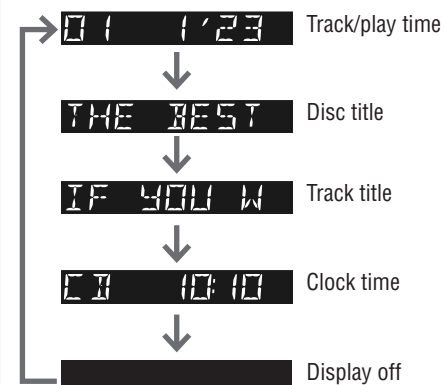

Random, Scan, Repeat Play  
(RANDOM, SCAN, REPEAT)

### Random Play

All the available tracks are played in a random sequence. Press **[4] (RANDOM)**. **[R▶]** lights. Press again to cancel.

### Scan Play

The first 10 seconds of each track is played in sequence. Press **[5] (SCAN)**. Press again to cancel.

### Repeat Play

The current track is repeated. Press **[6] (REPEAT)**. **[REP]** lights. Press again to cancel.

### Notes:

- To have another circle scroll while a title is displayed, press **[3] (SCROLL)**. If the number of displayed characters is 8 or less, the characters do not scroll.
- "NO TEXT" is displayed when there is no information on the disc.



## ⚠ Cautions

- This unit does not support 8 cm discs.
- Do not insert a disc when **DISC** indicator lights because a disc is already loaded.
- Do not use irregularly shaped discs. (→ page 26)
- Do not use discs that have a seal or label attached.
- To avoid damaging the face plate, do not push it down or

- place objects on it while it is open.
- Do not pinch your finger or hand in the face plate.
- Do not insert foreign matter into the disc slots.
- Refer to the section on "Notes on CD/CD Media (CD-ROM, CD-R, CD-RW)" (→ page 26).
- A disc which has both CD-DA data and MP3/WMA data on it may not be reproduced normally.
- Refer to the section on "Notes on MP3/WMA" (→ page 18).

## Operation Flow

When a disc is already loaded, press **[SOURCE]** to select the MP3/WMA mode.

**1** Press **[OPEN]** to open the face plate.

**2** Load a disc with the printed side facing up.

**Note:** It may take some time to start playing.

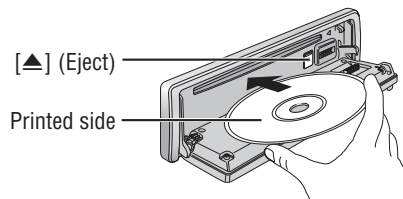

**3** Close the face plate manually.

### Notes:

- The unit recognizes the disc and starts playing automatically.
- The power will be turned on automatically when a disc is loaded.

### Disc Eject

- 1 Press **[OPEN]**.
- 2 Press **[▲]** and take the disc out.
- 3 Close the face plate manually.



**4** Select a desired portion.

### Folder Selection

- [^]** (FOLDER): Next folder
- [v]** (FOLDER): Preceding folder

### File Selection

- [▶▶]** (TRACK): Next file
  - [◀◀]** (TRACK): Preceding file (press twice)
- Note:** Hold down for fast forward/reverse.

### Pause

- Press **[▶||]**.
- Press again to cancel.

## MP3/WMA Mode Display

### Play Mode indicators

Lights when each mode is activated.

- [R▶]** Random play
- [REP]** Repeat play
- [FOLDER]** Folder Random, Folder Repeat, Folder Scan

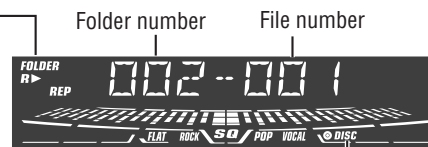

Lights when the disc is loaded.

## \*ID3/WMA Tag Setting

Hold down **[3] (SCROLL)** for 2 sec. or more.



### When a folder name is displayed:

- TAG ON: The album title is displayed.
- TAG OFF: The folder name is displayed.

### When a file name is displayed:

- TAG ON: The title/artist name is displayed.
- TAG OFF: The file name is displayed.

## Display Change (DISP: Display)

Press **[DISP]**.

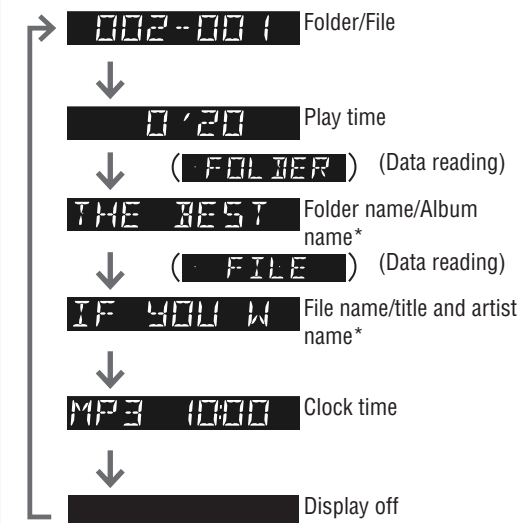

## Random, Scan, Repeat Play (RANDOM, SCAN, REPEAT)

### Random Play

All the available files are played in a random sequence. Press **[4] (RANDOM)**. **[R▶]** lights. Press again to cancel.

### Folder Random Play

All the files in the current folder are played in a random sequence. Hold down **[4] (RANDOM)** for 2 sec. or more. **[FOLDER] [R▶]** lights. Hold down again to cancel.

### Scan Play

The first 10 seconds of each file is played in sequence. Press **[5] (SCAN)**. Press again to cancel.

### Notes:

- To have another circle scroll while a text is displayed, press **[3] (SCROLL)**. If the number of displayed characters is 8 or less, the characters do not scroll.
- "NO TEXT" is displayed when there is no information on the disc.
- ID3/WMA tag information is displayed for the album name and title/artist name.

### Folder Scan Play

From the next folder, the first 10 seconds of the first file in each folder is played in sequence. Hold down **[5] (SCAN)** for 2 sec. or more. **[FOLDER]** lights. Hold down again to cancel.

### Repeat Play

The current file is repeated. Press **[6] (REPEAT)**. **[REP]** lights. Press again to cancel.

### Folder Repeat Play

The current folder is repeated. Hold down **[6] (REPEAT)** for 2 sec. or more. **[FOLDER] [REP]** lights. Hold down again to cancel.

## What is MP3/WMA?

MP3\* (MPEG Audio Layer-3) and WMA (Windows Media™ Audio) are the compression formats of digital audio. The former is developed by MPEG (Motion Picture Experts Group), and the latter is developed by Microsoft Corporation. Using these compression formats, you can record the contents of about 10 music CDs on a single CD media (This figures refer to data recorded on a 650 MB CD-R or CD-RW at a fixed bit rate of 128 kbps and a sampling frequency of 44.1 kHz).

\* MPEG Layer-3 audio coding technology licensed from Fraunhofer IIS and Thomson.

**Note:** MP3/WMA encoding and writing software is not supplied with this unit.

## Points to Remember When Making MP3/WMA Files

### Common

- High bit rate and high sampling frequency are recommended for high quality sounds.
- Selecting Variable Bit Rate (VBR) is not recommended because playing time is not displayed properly and sound may be skipped.
- The playback sound quality differs depending on the encoding circumstances. For details, refer to the instructions of your own encoding software and writing software.

### MP3

- It is recommended to set the bit rate to “128 kbps or more” and “fixed”.

### WMA

- It is recommended to set the bit rate to “64 kbps or more” and “fixed”.
- Do not set the copy protect attribute on the WMA file to enable this unit to play back.

## Caution

Never assign the “.mp3”, or “.wma” file name extension to a file that is not in the MP3/WMA format. This may not only produce noise from the speaker damage, but also damage your hearing.

## Display Information

### Displayed items

- **CD-TEXT**
  - Disc title
  - Track title
- **MP3 (ID3 tag)**
  - Album name
  - Title name/artist name
- **MP3/WMA**
  - Folder name
  - File name
- **WMA (WMA tag)**
  - Album name
  - Title name/artist name

### Displayable characters

- Displayable length of file name/folder name: within 32 characters. (Uncoded file and folder names are reduced by half in the number of displayable characters.)
- Name files and folders in accordance with the standard of each file system. Refer to the instructions of writing software for details.
- ASCII character set and special characters in each language can be displayed.
- Some Cyrillic characters in the Unicode can be displayed.

### ASCII character set

A to Z, a to z, digits 0 to 9, and the following symbols: (space) ! " # \$ % & ' ( ) \* + , - . / : ; < = > ? @ [ \ ] ^ \_ ` { | } ~

### Special Characters

À Á Â Ã Ä Å à á â ã ä å  
 Ä ä  
 Ò Ó Ô Õ Ö ö ó ô õ ö  
 Ù Ú Û Ü ü ú û

### Notes:

- With some software in which MP3/WMA format files have been encoded, the character information may not be displayed properly.
- Undisplayable characters and symbols will be converted into an asterisk (\*).
- It is recommended that the length of the file name is less than 8 (excluding the file extension).

Windows Media, and the Windows logo are trademarks, or registered trademarks of Microsoft Corporation in the United States and/or other countries/regions.



## Recording MP3/WMA Files on a CD-media

- You are recommended to minimize the chances of making a disc that contains both CD-DA files and MP3/WMA files.
- If CD-DA files are on the same disc as MP3 or WMA files, the songs may not play in the intended order, or some songs may not play at all.
- When storing MP3 data and WMA data on the same disc, use different folders for each data.
- Do not record files other than MP3/WMA files and unnecessary folder on a disc.
- The name of an MP3/WMA file should be added by rules as shown in the following descriptions and also comply with the rules of each file system.
- The file extension “.mp3” or “.wma” should be assigned to each file depending on the file format.
- You may encounter trouble in playing MP3/WMA files or displaying the information of MP3/WMA files recorded with certain writing software or CD recorders.
- This unit does not have a play list function.
- Although Multi-session recording is supported, the use of Disc-at-Once is recommended.

### Supported file systems

ISO 9660 Level 1/Level 2, Apple Extension to ISO 9660, Joliet, Romeo

**Note:** Apple HFS, UDF 1.50, Mix CD and CD Extra are not supported.

## Compression formats

(Recommendation: “Points to Remember When Making MP3/WMA Files” on the previous page)

Compression method	Bit rate	VBR	Sampling frequency
MPEG 1 audio layer 3 (MP3)	32 k – 320 kbps	Yes	32, 44.1, 48 kHz
MPEG 2 audio layer 3 (MP3)	8 k – 160 kbps	Yes	16, 22.05, 24 kHz
Windows Media Audio Ver. 7, 8, 9*	32 k – 192 kbps	Yes	32, 44.1, 48 kHz

\* WMA 9 Professional/LossLess/Voice are not supported.

## Folder Selection Order/File Playback Order

### Maximum number of files/folders

- Maximum number of files: 999
- Maximum number of files in one folder: 255
- Maximum depth of trees: 8
- Maximum number of folders: 255 (Root folder is included.)

### Notes:

- You can shorten the duration between data read and playback by decreasing the quantity of files or folders, or the depth of the hierarchy.
- This unit counts the number of folders irrespective of the presence or absence of an MP3/WMA file.
- If the selected folder does not contain any MP3/WMA files, the nearest MP3/WMA files in the order of playback will be played.
- Playback order may be different from other MP3/WMA players even if the same disc is used.
- “ROOT” appears when displaying the root folder name.

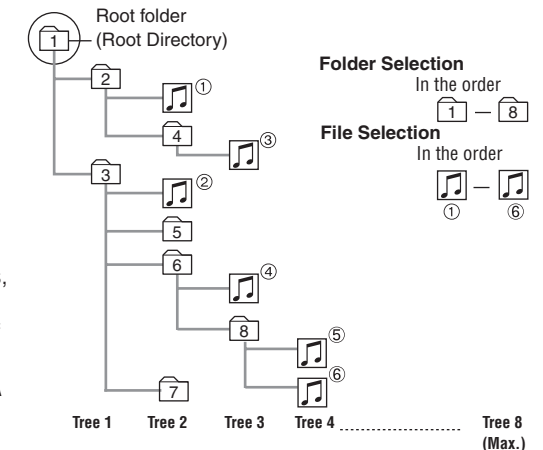

## Copyright

It is prohibited by copyright laws to copy, distribute and deliver copyrighted materials such as music without the approval of copyright holder except enjoying yourself personally.

## No warranty

Above description complies with our investigations as of September 2006. It has no warranty for reproducibility and displayability of MP3/WMA.

# Audio Setting

Adjustment to each speaker

- 1 Press [VOL] (PUSH SEL: Select) to open the menu. 

- 2 Press [VOL] (PUSH SEL: Select) to select a mode to be adjusted.

- 3 Turn [VOL] clockwise or counterclockwise to adjust. 

### Notes:

- The sequence and contents of setting items may depend on the conditions of devices to be connected. For further information, refer to the **System Upgrade Guidebook** or the instruction manuals for the devices to be connected.
- To return to the regular mode, press [DISP].
- If no operation takes place for more than 5 seconds in audio setting (2 seconds in the volume adjustment), the display returns to the regular mode.
- The volume can also be adjusted directly using [VOL] on the main unit. (→ page 10)
- Please refer to page 11 for SQ selection.

## Volume Adjustment

(Setting range: 0 to 40, Default: 18)

- ①: Up
- ②: Down

VOL 18

## Bass Adjustment

(Setting range: -12 dB to +12 dB, 2 dB Step, Default: Bass 0 dB)

- ①: Up
- ②: Down

BAS 0dB

## Treble Adjustment

(Setting range: -12 dB to +12 dB, 2 dB Step, Default: Treble 0 dB)

- ①: Up
- ②: Down

TRE 0dB

**Note:** Setting of SQ, bass/treble and volume are influenced one another. If such an influence mentioned above causes distortion to the audio signal, readjust bass/treble or volume.

## Balance Adjustment

(Setting range: L (left) 15 to R (right) 15 and Center, Default: Center)

- ①: Right enhanced
- ②: Left enhanced

BAL CNT

## Fader Adjustment

(Setting range: R (rear) 15 to F (front) 15 and Center, Default: Center)

- ①: Front enhanced
- ②: Rear enhanced

FAD CNT

# Function Setting

- 1 Hold down [VOL] (PUSH SEL: Select) for 2 sec. or more to open the menu. 

- 2 Press [VOL] (PUSH SEL: Select) to select a mode to be adjusted.

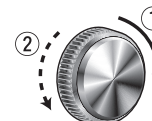
- 3 Turn [VOL] clockwise or counterclockwise to adjust. 

### Notes:

- The sequence and contents of setting items may depend on the conditions of devices to be connected. For further information, refer to the **System Upgrade Guidebook** or the instruction manuals for the devices to be connected.
- To return to the regular mode, press [DISP].
- If no operation takes place for more than 5 seconds in function setting, the display returns to the regular mode.

## Demonstration

You can set up the monitor to display or hide the demonstration screen.

- ①: On (Default)

DEMO ON

- ②: Off

DEMO OFF

**Note:** Button operation with either the main unit or remote control allows users to cancel the demonstration screen for 20 seconds and enable the selected operation even in the demo-on mode.

## Key Color Selection

You can select key color.

Default: GREEN (Green)

Variety: GREEN (Green), RED (Red)

- ①: Green (Default)

GREEN

- ②: Red

RED

## Level Meter Display Patterns (PATTERN)

Variety: 4 types, OFF

- ① : Off
- ② : Pattern 1 (Default)
- ③ : Pattern 2
- ④ : Pattern 3
- ⑤ : Pattern 4

## Mute/Attenuation

You can select mute or attenuation.

- ①: Volume down by 10 steps

KEY ATT

- ②: Volume off (Default)

KEY MUTE

## AUX1 Skip

If AUX1 is not used, the AUX1 mode is skipped when selecting the source.

- ①: On (Skip disabled.) (Default)

AUX1 ON

- ②: Off (Skip enabled.)

AUX1 OFF

## If You Suspect Something Wrong

Check and take steps as described below.

If the described suggestions do not solve the problem, it is recommended to take the unit to your nearest authorized Panasonic Service Center. The product should be serviced only by qualified personnel. Please refer the checking and the repair to professionals. Panasonic shall not be liable for any accidents arising out of neglect of checking the unit or your own repair after your checking.

**Never take measures especially those other than indicated by *italic* letters in "Possible solution" described below because those are too dangerous for users to handle themselves.**

### Warning

- Do not use the unit in an irregular condition, for example, without sound, or with smoke or a foul smell, which can cause ignition or electric shock. Immediately stop using the unit and consult your dealer.
- Never try to repair the unit by yourself because it is dangerous to do so.

Problem	Possible cause → Possible solution
No power to the unit	The power cord (battery, power and ground) is connected in the wrong way. → <b>Check the wiring.</b>
	Fuse blows out. → <b>Eliminate the cause of fuse blowout and replace the fuse with new one. Consult your dealer.</b>
Sound is not generated.	MUTE is set to ON. → <b>Set MUTE to OFF.</b>
	The wiring of speaker lines are not correct, or a break or poor contact arises. → <b>Check the wiring in accordance with the wiring diagram. (→ Installation Instructions)</b>
Noise	There is an electromagnetic-wave generator such as a cellular phone near the unit or its electrical lines. → <b>Keep an electromagnetic-wave generator such as a cellular phone away from the unit and the wiring of the unit. In case that noise cannot be eliminated due to the wiring harness of the car, consult your dealer.</b>
	The contact of the ground lead is poor. → <b>Make sure that the ground lead is connected to an unpainted part of the chassis securely.</b>
Noise is made in step with engine revolutions.	Alternator noise comes from the car. → <b>Change the wiring position of the ground lead.</b> → <b>Mount a noise filter.</b>

Problem	Possible cause → Possible solution
Some operations are not executable.	Some operations are not executable in particular modes such as menu mode. → <b>Read the operating instructions carefully and cancel the mode. If the unit is still out of order, consult your dealer.</b>
No sound from speaker(s)	Balance/Fader setting is not appropriate. → <b>Readjust Balance/Fader.</b>  There is a break, a short circuit, poor contact or wrong wiring regarding the speaker wiring. → <b>Check the speaker wiring.</b>
The speaker channels are reversed between right and left.	The speaker wiring is confused between right and left. → <b>Perform the speaker wiring in accordance with the wiring diagram.</b>
The sound field is not clear in the stereo mode. Central sound does not settled.	The plus and minus terminals at right and left channels of speakers are connected reversely. → <b>Perform the speaker wiring in accordance with the wiring diagram.</b>
The power fails unintentionally.	The safety device works. → <b>Consult your dealer, or your nearest Panasonic Service Center.</b>

Common (continued)

Poor reception or noise	Antenna installation or wiring of antenna cable is faulty. → <b>Check whether the antenna mounting position and its wiring are correct. In addition, check to see whether the antenna ground is securely connected to the chassis.</b>  No power is supplied to the antenna amplifier (when using a film antenna, etc.). → <b>Check the wiring of the antenna power lead.</b>
The number of auto preset stations is less than 6.	The number of receivable stations is less than 6. → <b>Move to an area where receivable stations number is maximum, and try presetting.</b>
Preset stations cannot be stored.	The contact of the battery lead is poor, or the battery lead is not always powered. → <b>Make sure that the battery lead is connected securely, and preset stations again.</b>

Radio

Common

English

Troubleshooting

CD

Problem	Possible cause → Possible solution
No playback or disc ejected	<p>The disc is inserted upside down. → <b>Insert a disc correctly.</b></p> <p>There is a flaw or foreign material on the disc. → <b>Remove the foreign material, or use a flawless disc.</b></p>
Sound skipping or noise	<p>There is a flaw or foreign material on the disc. → <b>Remove the foreign material, or use a flawless disc.</b></p>
Sound skipping due to vibration	<p>The unit is not sufficiently secured. → <b>Secure the unit to the console box.</b></p> <p>The unit is tilted at over 30° in the front-to-end direction. → <b>Make the angle 30° or less.</b></p>
Disc unejectable	<p>Something such as a peeled label obstructs the disc coming out. → <b>Consult your dealer.</b></p> <p>The microcontroller in the unit operates abnormally due to noise or other factors. → <b>Unplug the power cord and plug it again. In case the unit is still out of order, consult your dealer.</b></p>

MP3/WMA

No playback or disc ejected	<p>The disc has unplayable formatted data. → <b>Refer to the description about MP3/WMA for playable sound data except CD-DA (i.e. music CD).</b></p>
The CD-R/RWs that are playable on other devices are not playable on this unit.	<p>The playability of some CD-R/RWs may depend on the combination of media, recording software and recorder to be used even if these CD-R/RWs are playable on other devices such as a PC. → <b>Make CD-R/RWs in different combination of media, recording software and recorder after referring to the description about MP3/WMA.</b></p>
Sound skipping or noise	<p>There is a flaw or foreign material on the disc. → <b>Remove the foreign material, or use a flawless disc. For MP3/WMA, refer to the description about MP3/WMA.</b></p> <p>Playing Variable Bit Rate (VBR) files may cause sound skipping. → <b>Play Non-VBR files.</b></p>

Remote control unit

Problem	Possible cause → Possible solution
No response to pressing buttons	<p>The battery is inserted in the wrong direction. A wrong battery is inserted. → <b>Insert a correct battery in the correct direction.</b></p>
	<p>The battery is weak. → <b>Replace the battery with new one.</b></p>
	<p>The aiming direction of the remote control unit is wrong. → <b>Aim the remote control unit at the sensor of the unit and press buttons.</b></p> <p>The sensor is exposed to direct sunlight. (The remote control unit may not be operable when the sensor is exposed to direct sunlight. In such a case, the system is not faulty.) → <b>Block off sunlight to the sensor.</b></p>

CD/MP3/WMA

## Error Display Messages

Display	Possible cause → Possible solution
<p>--E1--</p> <p>--E2--</p> <p>--E3--</p> <p>(After 5 seconds)</p> <p>↓</p> <p>CD EJECT</p>	<p>The disc is dirty or upside down. → <b>Check the disc.</b></p> <p>The disc has scratches. → <b>Check the disc.</b></p> <p>No operation by some cause. → <b>Unplug the power cord and plug it again. In case the unit is still out of order, consult your dealer. (→ Installation Instructions)</b></p>
<p>--E4--</p> <p>(After 5 seconds)</p> <p>↓</p> <p>To next file automatically</p>	<p>The player for some reason cannot read the file you are trying to play. (File recorded in an unsupported file system, compression scheme, data format, file name extension, damaged data, etc.) → <b>Select a file that the player can read. Check the type of data recorded on the disc. Create a new disc if necessary.</b></p>
<p>--E5--</p> <p>(After 5 seconds)</p> <p>↓</p> <p>To next file automatically</p>	<p>A WMA file can be copyrighted. → <b>The file protected by copyright is not playable.</b></p>

**Note:** Refer to the **System Upgrade Guidebook** for error messages regarding optional products.

If you use commercial CDs, they must have either of these labels shown at right. Some copy-protected music CDs are not playable.



### How to hold the disc

- Do not touch the underside of the disc.
- Do not scratch on the disc.
- Do not bend the disc.
- When not in use, keep disc in the case.

### Do not leave discs in the following places:

- In direct sunlight
- Near car heaters
- Dirty, dusty and damp areas
- On seats and dashboards

### Disc cleaning

Use a dry, soft cloth to wipe from the center outward.



Do not write on the disc label with a ballpoint pen or other hard-point pens.

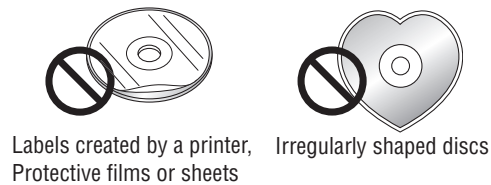
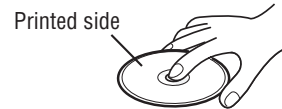

Labels created by a printer, Protective films or sheets Irregularly shaped discs

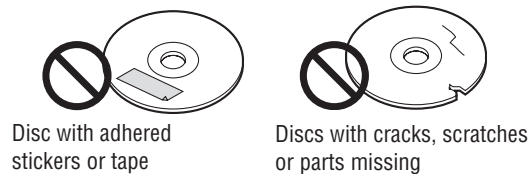

Disc with adhered stickers or tape Discs with cracks, scratches or parts missing

- You may have trouble playing back some CD-R/RW discs recorded on CD recorders (CD-R/RW drives), either due to their recording characteristics or dirt, fingerprints, scratches, etc. on the disc surface.
- CD-R/RW discs are less resistant to high temperatures and high humidity than ordinary music CDs. Leaving them inside a car for extended periods may damage and make playback impossible.
- Some CD-R/RWs can not be played back successfully thanks to incompatibility among writing software, a CD recorder (CD-R/RW drive) and the discs.
- This player cannot play the CD-R/RW discs if the session is not closed.
- This player cannot play the CD-R/RW discs which contains other than CD-DA or MP3/WMA data.
- Be sure to observe the instructions of CD-R/RW disc for handling it.

# Maintenance/Fuse

Your product is designed and manufactured to ensure the minimum of maintenance. Use a dry, soft cloth for routine exterior cleaning. Never use benzine, thinner, or other solvents.

If the fuse blows out, consult your dealer, or your nearest authorized Panasonic Service Center.

### Warning

- Use fuses of the same specified rating (**15 A**). Using substitutes or fuses with higher ratings, or connecting the unit directly without a fuse could cause fire or damage to the unit. **If the replaced fuse fails, contact your nearest authorized Panasonic Service Center.**

<b>Power Supply</b>	DC 12 V (11 V – 16 V), Test Voltage 14.4 V, Negative Ground
<b>Current Consumption</b>	Less than 2.1 A (CD mode, 0.5 W 4-Speaker)
<b>Maximum Power Output</b>	50 W x 4 (at 1 kHz), volume control maximum
<b>Power Output</b>	18 W x 4 CH (1 kHz, 1 %, 4 Ω)
<b>Tone Adjustable Range</b>	Bass: ±12 dB (at 100 Hz), Treble: ±12 dB (at 10 kHz)
<b>Speaker Impedance</b>	4 – 8 Ω
<b>Pre-amp Output Voltage</b>	2.5 V (CD mode: 1 kHz, 0 dB)
<b>Pre-amp Output Impedance</b>	200 Ω
<b>Front AUX input</b>	
<b>Input Impedance</b>	10 kΩ
<b>Allowable External Input Connector</b>	3.5 mm φ Stereo mini-pin
<b>Dimensions (Main Unit)</b>	178 (W) x 50 (H) x 160 (D) mm
<b>Weight (Main Unit)</b>	1.3 kg

<b>Sampling Frequency</b>	8 times oversampling
<b>DA Converter</b>	1 bit DAC System
<b>Pick-Up Type</b>	Astigma 3-beam
<b>Light Source</b>	Semiconductor laser
<b>Wave Length</b>	790 nm
<b>Frequency Response</b>	20 Hz – 20 kHz (±1 dB)
<b>Signal to Noise Ratio</b>	96 dB
<b>Total Harmonic Distortion</b>	0.01 % (1 kHz)
<b>Wow and Flutter</b>	Below measurable limits
<b>Channel Separation</b>	75 dB

<b>FM</b>	
<b>Frequency Range</b>	87.50 MHz – 108.00 MHz
<b>Usable Sensitivity</b>	6 dB/μV (S/N 30 dB)
<b>Frequency Response</b>	30 Hz – 15 kHz (±3 dB)
<b>Alternate Channel Selectivity</b>	75 dB
<b>Stereo Separation</b>	35 dB (at 1 kHz)
<b>Image Rejection Ratio</b>	70 dB
<b>IF Rejection Ratio</b>	100 dB
<b>Signal to Noise Ratio</b>	62 dB
<b>AM</b>	
<b>Frequency Range</b>	531 kHz – 1 602 kHz
<b>Usable Sensitivity</b>	28 dB/μV (S/N 20 dB)

### Notes:

- Specifications and design are subject to modification without notice due to improvements.
- Some figures and illustrations in this manual may be different from your product.







# Panasonic

## System Upgrade Guidebook Инструкция по расширению системы 系統昇級手冊 시스템 업그레이드 가이드북

Model: **CQ-C5305W/CQ-C3305W**



- For upgrading your system, read this manual carefully before use. This manual should be retained for future reference after read.
- Для расширения Вашей системы просим тщательно читать данную перед использованием аппарата. Данную инструкцию следует хранить для дальнейшего пользования.
- 昇級系統前仔細閱讀本說明書。閱讀後應保留本說明書以備將來參考。
- 시스템의 업그레이드를 하기 전에 본 설명서를 숙독하시고 읽으신 후에는 잘 보관하셔서 필요시에 참고하시기 바랍니다.

■ Read the operating instructions for the unit and all other components of your car audio system carefully before using the system. They contain instructions about how to use the system in a safe and effective manner. Panasonic assumes no responsibility for any problems resulting from failure to observe the instructions given in this manual.

 **Warning** This pictograph intends to alert you to the presence of important operating instructions and installation instructions. Failure to heed the instructions may result in severe injury or death.

■ This manual uses pictographs to show you how to use the product safely and to alert you to potential dangers resulting from improper connections and operations. The meanings of the pictographs are explained below. It is important that you fully understand the meanings of the pictographs in order to use this manual and the system properly.

 **Caution** This pictograph intends to alert you to the presence of important operating instructions and installation instructions. Failure to heed the instructions may result in injury or material damage.

 **Warning**  
Observe the following warnings when using this unit.

- ❑ **The driver should neither watch the display nor operate the system while driving.**  
Watching the display or operating the system will distract the driver from looking ahead of the vehicle and can cause accidents. Always stop the vehicle in a safe location and use the parking brake before watching the display or operating the system.
- ❑ **Use the proper power supply.**  
This product is designed for operation with a negative grounded 12 V DC battery system. Never operate this product with other battery systems, especially a 24 V DC battery system.
- ❑ **Keep batteries and insulation film out of reach of infants.**  
Batteries and insulation film can be ingested, so keep them out of the reach of infants. If an infant ingests a battery or insulation film, please seek immediate medical attention.
- ❑ **Protect the Deck Mechanism.**  
Do not insert any foreign objects into the slot of this unit.
- ❑ **Do not disassemble or modify the unit.**  
Do not disassemble, modify the unit or attempt to repair the product yourself. If the product needs to be repaired, consult your dealer or an authorized Panasonic Service Center.
- ❑ **Do not use the unit when it is out of order.**  
If the unit is out of order (no power, no sound) or in an abnormal state (has foreign objects in it, is exposed to water, is smoking, or smells), turn it off immediately and consult your dealer.
- ❑ **The remote control unit should not lie about in the car.**  
If the remote control unit lies about, it could fall on the floor while driving, get wedged under the brake pedal, and lead to a traffic accident.
- ❑ **Refer fuse replacement to qualified service personnel.**  
When the fuse blows out, eliminate the cause and have it replaced with the fuse prescribed for this unit by a qualified service engineer. Incorrect replacement of the fuse may lead to smoke, fire, and damage to the product.

**Observe the following warnings when installing.**

- ❑ **Disconnect the lead from the negative (–) battery terminal before installation.**  
Wiring and installation with the negative (–) battery terminal connected may cause electrical shock and injury due to a short circuit.  
Some cars equipped with the electrical safety system have specific procedures of battery terminal disconnection.  
**FAILURE TO FOLLOW THE PROCEDURE MAY LEAD TO THE UNINTENDED ACTIVATION OF THE ELECTRICAL SAFETY SYSTEM RESULTING IN DAMAGE TO THE VEHICLE AND PERSONAL INJURY OR DEATH.**
- ❑ **Never use safety-related components for installation, grounding, and other such functions.**  
Do not use safety-related vehicle components (fuel tank, brake, suspension, steering wheel, pedals, airbag, etc.) for wiring or fixing the product or its accessories.
- ❑ **Installing the product on the air bag cover or in a location where it interferes with airbag operation is prohibited.**
- ❑ **Check for piping, gasoline tank, electric wiring, and other items before installing the product.**  
If you need to open a hole in the vehicle chassis to attach or wire the product, first check where the wire harness, gasoline tank, and electric wiring are located. Then open the hole from outside if possible.
- ❑ **Never install the product in a location where it interferes with your field of vision.**
- ❑ **Never have the power cord branched to supply other equipment with power.**
- ❑ **After installation and wiring, you should check the normal operation of other electrical equipment.**  
The continuation of their using in abnormal conditions may cause fire, electrical shock or a traffic accident.
- ❑ **In the case of installation to an airbag-equipping car, confirm warnings and cautions of the vehicle manufacturer before installation.**
- ❑ **Make sure the leads do not interfere with driving or getting in and out of the vehicle.**
- ❑ **Insulate all exposed wires to prevent short circuiting.**

 **Caution**  
Observe the following cautions when using this unit.

- ❑ **Keep the sound volume at an appropriate level.**  
Keep the volume level low enough to be aware of road and traffic conditions while driving.
- ❑ **This unit is designed for use exclusively in automobiles.**
- ❑ **Do not operate the unit for a prolonged period with the engine turned off.**  
Operating the audio system for a long period of time with the engine turned off will drain the battery.
- ❑ **Do not expose the unit to direct sunlight or excessive heat.**  
Otherwise these will raise the interior temperature of the unit, and it may lead to smoke, fire, or other damage to the unit.
- ❑ **Do not use the product where it is exposed to water, moisture, or dust.**  
Exposure of the unit to water, moisture, or dust may lead to smoke, fire, or other damage to the unit. Make especially sure that the unit does not get wet in car washes or on rainy days.
- ❑ **Set the volume level to low enough before the AUX connection is completed.**  
Failure to observe this, the loud noise may come out and damage your speakers and your hearing. Direct connection of the speaker/headphone output of an external device without any attenuator may distort sound or damage the connected external device.

**Observe the following cautions when installing.**

- ❑ **Refer wiring and installation to qualified service personnel.**  
Installation of this unit requires special skills and experience. For maximum safety, have it installed by your dealer. Panasonic is not liable for any problems resulting from your own installation of the unit.
- ❑ **Follow the instructions to install and wire the product.**  
Not following the instructions to properly install and wire the product could cause an accident or fire.
- ❑ **Take care not to damage the leads.**  
When wiring, take care not to damage the leads. Prevent them from getting caught in the vehicle chassis, screws, and moving parts such as seat rails. Do not scratch, pull, bend or twist the leads. Do not run them near heat sources or place heavy objects on them. If leads must be run over sharp metal edges, protect the leads by winding them with vinyl tape or similar protection.
- ❑ **Use the designated parts and tools for installation.**  
Use the supplied or designated parts and appropriate tools to install the product. The use of parts other than those supplied or designated may result in internal damage to the unit. Faulty installation may lead to an accident, a malfunction or fire.

Refer to safety information of optional devices as well.

- ❑ **Do not block the air vent or the cooling plate of the unit.**  
Blocking these parts will cause the interior of the unit to overheat and will result in fire or other damage.
  - ❑ **Do not install the product where it is exposed to strong vibrations or is unstable.**  
Avoid slanted or strongly curved surfaces for installation. If the installation is not stable, the unit may fall down while driving and this can lead to an accident or injury.
  - ❑ **Installation Angle**  
The product should be installed in a horizontal position with the front end up at a convenient angle, but not more than 30°. The user should bear in mind that in some areas there may be restrictions on how and where this unit must be installed. Consult your dealer for further details.
  - ❑ **Wear gloves for safety. Make sure that wiring is completed before installation.**
  - ❑ **To prevent damage to the unit, do not connect the power connector until the whole wiring is completed.**
  - ❑ **Do not connect more than one speaker to one set of speaker leads. (except for connecting to a tweeter)**
- Observe the following cautions when handling the battery for the remote control unit.**

- CQ-C5305W**
- Use only specified battery (CR2025).
  - Match the polarity of the battery with the (+) and (–) marks in the battery case.
  - Replace a dead battery as soon as possible.
  - Remove the battery from the remote control unit when not using it for an extended period of time.
  - Insulate the battery (by placing them in a plastic bag or covering them with vinyl tape) before disposal or storage.
  - Dispose of the battery according to the local regulations.
  - Do not disassemble, recharge, heat or short the battery. Do not throw a battery into a fire or water.
- In case of battery leakage**
- Thoroughly wipe the battery liquid off the battery case and insert new battery.
  - If any part of your body or clothing comes into contact with battery liquid, wash it with plenty of water.
  - If battery liquid comes into contact with your eyes, wash them with plenty of water and get immediate medical attention.

This book is an instruction manual that explains how to operate your purchased head unit and its remote control as an accessory when the head unit is connected to optional devices.  
(Remote Control Unit → Operating Instructions)

### Head units to be targeted

- CQ-C5305W  
(Notation in this book: **CQ-C5305W**)
- CQ-C3305W  
(Notation in this book: **CQ-C3305W**)

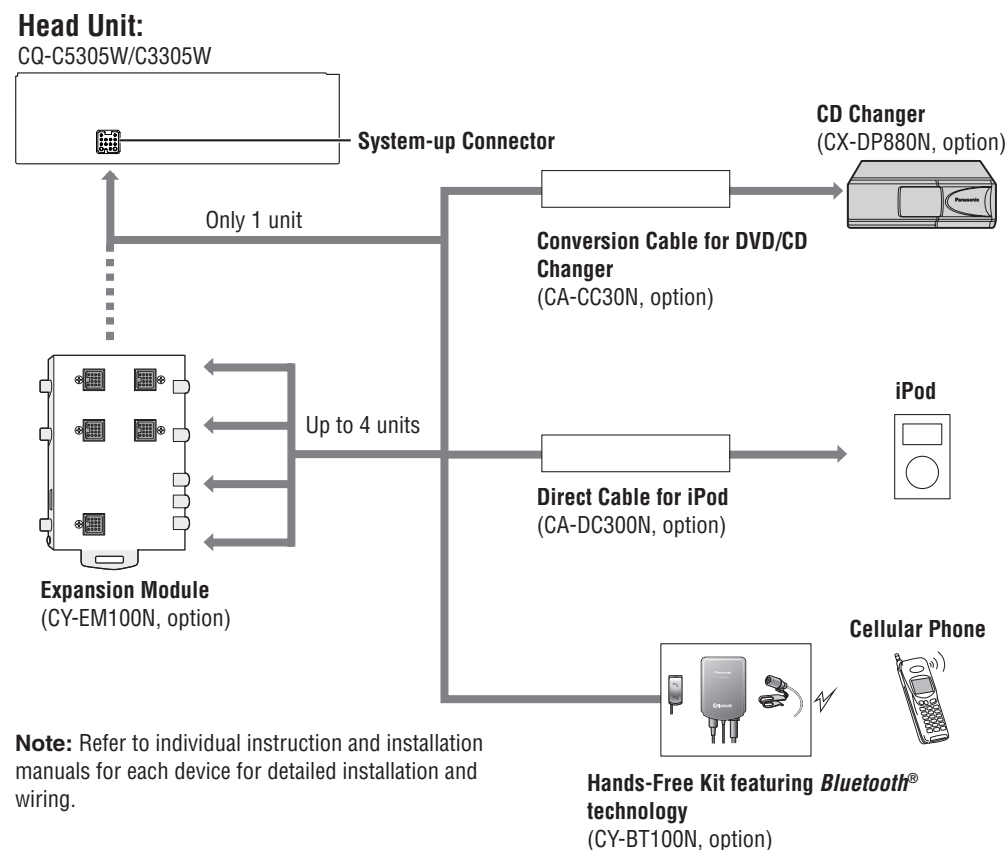
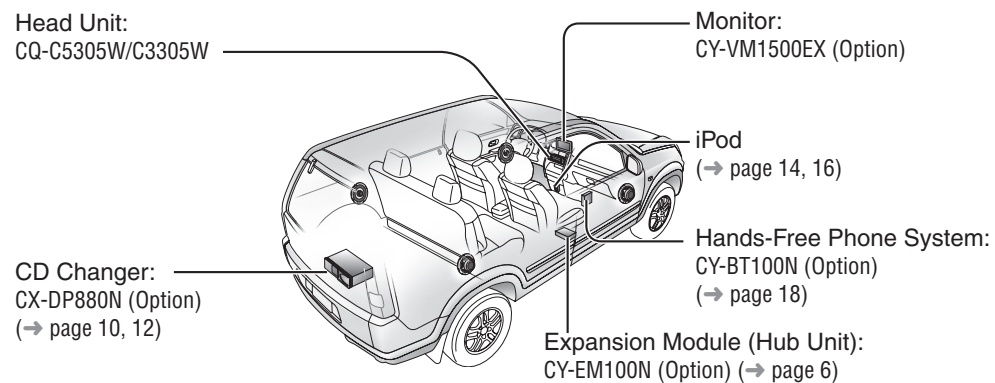

## English

Русский	22
中文	42
한국어	62

• Safety Information	2
• Before Reading These Instructions	4

• General	6
• CD Changer	10
• iPod Control	14
• Hands-Free Phone System	18

• Troubleshooting	20
-------------------	----

## CD Changer

The optional adapter (Conversion Cable for DVD/CD Changer: CA-CC30N) allows you to connect the optional Panasonic CD changer unit (CX-DP880N). For details, refer to the operating instructions for the CD changer unit. (→ page 10, 12)

### Note:

- This unit does not support a DVD changer due to shortage of displayable digit number or other causes.

## iPod

The optional adapter (Direct Cable for iPod: CA-DC300N) allows you to connect the optional iPod series. (→ page 14, 16)

The iPod equipped with a dock connector is exclusively connectable. Further information about the controllable iPod is described below.

### Controllable iPod/software version

- 3rd generation iPod/ver. 2.3
- 4th generation iPod/ver. 3.1.1
- 5th generation iPod/ver. 1.2 (Video playback is not supported.)
- iPod photo/ver. 1.2.1
- iPod mini/ver. 1.4.1
- iPod nano/ver. 1.2

\* Operation check has been completed with software available at the end of September, 2006. We do not guarantee the operation with our future products or upgraded software.

iPod is a trademark of Apple Computer, Inc., registered in the U.S.A. and other countries.

## Hands-Free Phone System

You can connect the optional Hands-Free Phone System (Hands-Free Kit featuring Bluetooth® technology: CY-BT100N). For details, refer to the operating instructions for the Hands-Free Phone System. (→ page 18)

**Note:** This unit is designed **only for receiving calls**. It cannot send calls.

### Bluetooth®

The Bluetooth word mark and logo are owned by the Bluetooth SIG, Inc. and any use of such marks by Matsushita Electric Industrial Co., Ltd. is under license. Other trademarks and trade name are those of their respective owners.

## Expansion Module (Hub Unit)

You can connect the optional Expansion Module (hub unit) (CY-EM100N). Connection of the Expansion Module allows you to simultaneously connect optional devices mentioned before as well as other AV devices. For details, refer to the operating instructions for the Expansion Module.

Connectable devices

- CD changer (max. 1)
- iPod (max. 2)
- Hands-Free Phone System (max. 1)

**Note:** Market conditions regarding optional devices vary with countries and regions. For further information, consult your dealer.

## CQ-C5305W

The source changes as follows every time [SOURCE] is pressed.



### When an Expansion Module is Connected to System-up Connector

Source Selection (SOURCE)

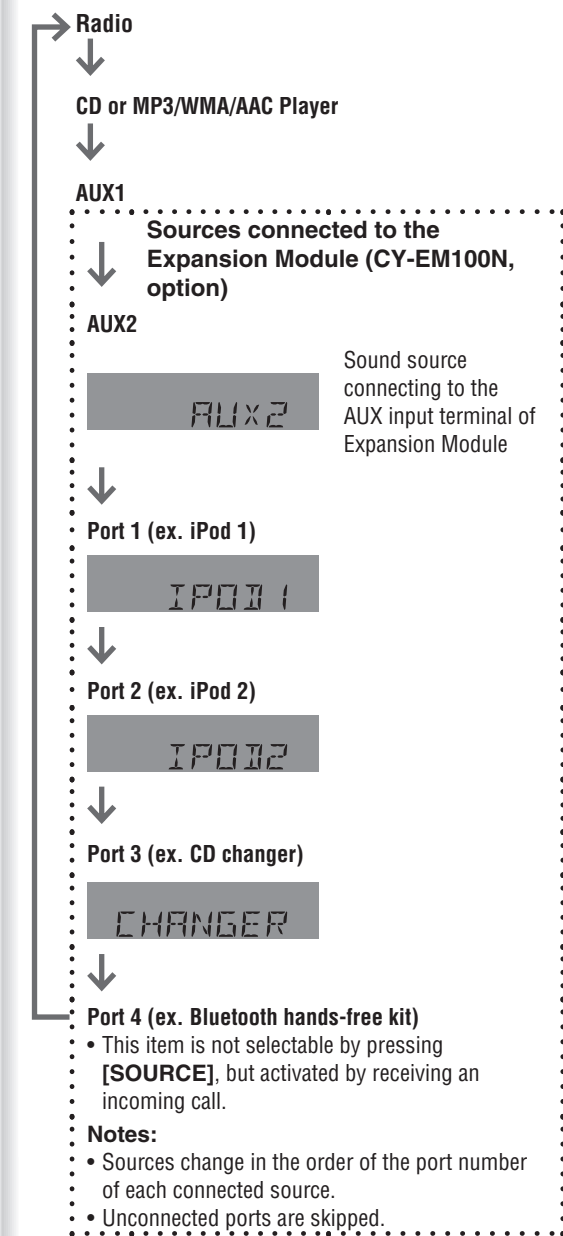

### When an Optional Device is Connected to System-up Connector

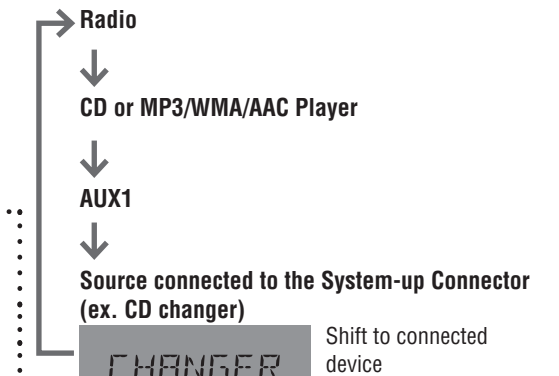

**CQ-C3305W**

The source changes as follows every time [SOURCE] is pressed.



**When an Expansion Module is Connected to System-up Connector**

Source Selection (SOURCE)

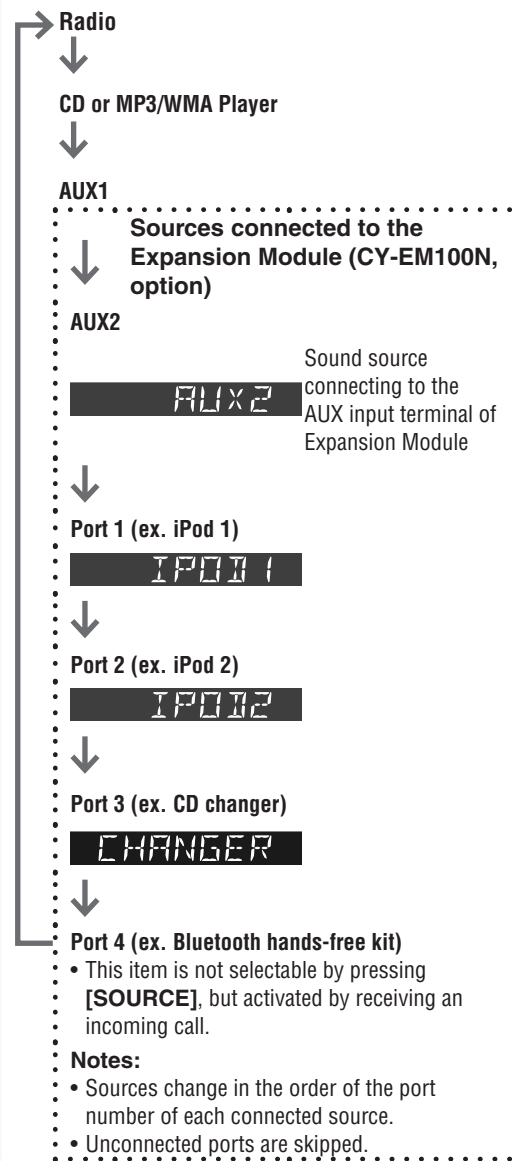

**CQ-C3305W**

The source changes as follows every time [SOURCE] is pressed.



**When an Optional Device is Connected to System-up Connector**

Source Selection (SOURCE)

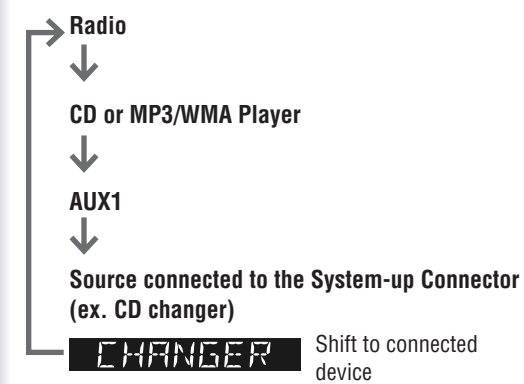

Connected an optional CD changer can be controlled by this unit.

**1** Load a magazine (discs).  
When a magazine is already loaded, press **[SOURCE]** to select the CD changer mode.

The unit recognizes the magazine and starts playing automatically.

**2** Select a desired portion.



### Disc Selection

**[^]** (DISC): Next disc  
**[v]** (DISC): Preceding disc

### Track Selection

**[▶▶]** (TRACK): Next track  
**[◀◀]** (TRACK): Preceding track (press twice)  
**Note:** Hold down for fast forward/reverse.

### Play Mode indicators

Lights when each mode is activated.

- R▶** Random play
- REP** Repeat play
- DISC** Disc Random, Disc Repeat, Disc Scan

Lights when the changer is connected.



Press **[DISP]**.

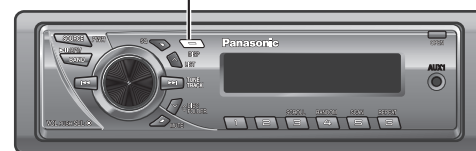
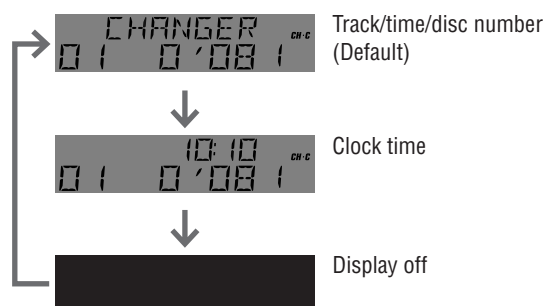

### Random Play

All the available tracks are played in a random sequence. Press **[4] (RANDOM)**. **R▶** lights. Press again to cancel.

### Disc Random Play

All the available tracks on the current disc are played in a random sequence. Hold down **[4] (RANDOM)** for 2 sec. or more. **DISC R▶** lights. Hold down again to cancel.

### Scan Play

The first 10 seconds of each track is played in sequence. Press **[5] (SCAN)**. Press again to cancel.

### Disc Scan Play

From the next disc, the first 10 seconds of the first track of all the discs is played in sequence. Hold down **[5] (SCAN)** for 2 sec. or more. **DISC** lights. Hold down again to cancel.

### Repeat Play

The current track is repeated. Press **[6] (REPEAT)**. **REP** lights. Press again to cancel.

### Disc Repeat Play

The current disc is repeated. Hold down **[6] (REPEAT)** for 2 sec. or more. **DISC REP** lights. Hold down again to cancel.

### Direct Access

A disc can be directly selected.

**Example:** disc number 5

- 1 Press **[#] (NUMBER)**.
- 2 Press **[5]**.
- 3 Press **[SET]**.



### Notes:

- To suspend direct selection, press **[DISP]**.
- Random, Disc Random, Scan, Disc Scan, Repeat and Disc Repeat plays are canceled once **[#]** is pressed.

### Notes:

- Trouble may occur while playing CD-Rs. Refer to the section on "Notes on CD/CD Media (CD-ROM, CD-R, CD-RW)". (→ Operating Instructions)

- This unit does not support the following through the CD changer.
  - **CD-RW playback. (except when CX-DP880N is connected)**
  - **MP3/WMA/AAC playback.**
  - **CD text display.**
- Pausing does not function in the CD changer mode.

Connected an optional CD changer can be controlled by this unit.

**1 Load a magazine (discs).**  
When a magazine is already loaded, press **[SOURCE]** to select the CD changer mode.

The unit recognizes the magazine and starts playing automatically.

**2 Select a desired portion.**



**Disc Selection**

**[^] (DISC):** Next disc  
**[v] (DISC):** Preceding disc

**Track Selection**

**[>>] (TRACK):** Next track  
**[<<] (TRACK):** Preceding track (press twice)  
**Note:** Hold down for fast forward/reverse.

**Play Mode indicators**  
Lights when each mode is activated.

- R▶** Random play
- REP** Repeat play
- DISC** Disc Random, Disc Repeat, Disc Scan

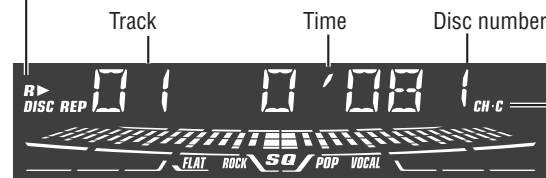

Lights when the changer is connected.

Press **[DISP]**.

- **01 0'08 1** Track/time/disc number (Default)
- ↓
- 12:10** Clock time
- ↓
- [Blank]** Display off



**Notes:**

- Trouble may occur while playing CD-Rs. Refer to the section on "Notes on CD/CD Media (CD-ROM, CD-R, CD-RW)". (→ Operating Instructions)

- This unit does not support the following through the CD changer.
  - **CD-RW playback.** (except when **CX-DP880N** is connected)
  - **MP3/WMA playback.**
  - **CD text display.**
- Pausing does not function in the CD changer mode.

**Random Play**

All the available tracks are played in a random sequence. Press **[4] (RANDOM)**. **R▶** lights. Press again to cancel.

**Disc Random Play**

All the available tracks on the current disc are played in a random sequence. Hold down **[4] (RANDOM)** for 2 sec. or more. **DISC R▶** lights. Hold down again to cancel.

**Scan Play**

The first 10 seconds of each track is played in sequence. Press **[5] (SCAN)**. Press again to cancel.

**Disc Scan Play**

From the next disc, the first 10 seconds of the first track of all the discs is played in sequence. Hold down **[5] (SCAN)** for 2 sec. or more. **DISC** lights. Hold down again to cancel.

**Repeat Play**

The current track is repeated. Press **[6] (REPEAT)**. **REP** lights. Press again to cancel.

**Disc Repeat Play**

The current disc is repeated. Hold down **[6] (REPEAT)** for 2 sec. or more. **DISC REP** lights. Hold down again to cancel.

Connection of the optional direct cable for iPod (CA-DC300N) allows users to operate the iPod including file selection and file sequence change with the buttons on this unit.

- 1 Connect the iPod.
- 2 Press **[SOURCE]** to select the iPod mode. Playback starts.  
**Note:** If playback does not start, press **[BAND]** (▶||).
- 3 Select a desired portion.



### File Selection

- [▶▶]: Next file
- [◀◀]: Beginning of the current file  
For the preceding file, press twice.

#### Notes:

- Hold down for fast forward/reverse.
- When fast forward comes to the end of a file or fast reverse comes to the beginning of a file, regular playback starts even if the fast forward or reverse button is pressed.

### Pause

- Press **[BAND]** (▶||).
- Press again to cancel.

- 1 Press **[^]** (LIST) to activate the Playing Mode Selection mode.
- 2 Turn **[VOL]** clockwise or counterclockwise to adjust.
  - ① PLAYLIST: Playback by playlist (Default)
  - ② ARTIST: Playback by artist
  - ③ ALBUM: Playback by album
- 3 Press **[VOL]** (PUSH SEL: Select) to determine the selection.
- 4 Turn **[VOL]** clockwise or counterclockwise to select a portion to be played.
- 5 Press **[VOL]** (PUSH SEL: Select) to determine the selection.  
**Note:** To select playing mode in step 2, press **[^]** (LIST).

#### Notes:

- To return to the regular mode, press **[DISP]**.
- Files without an album name or an artist name are not playable in the playing mode of the album or artist display respectively.

### Play Mode indicators

- Lights when each mode is activated.
- REP** Repeat play
- R▶** Shuffle play (songs)
- Blinks when each mode is activated.
- R▶** Shuffle play (albums)

iPod number, 1 (iPod 1)/2 (iPod 2),  
Lights when the Expansion Module  
(CY-EM100N) is connected.

Lights when the direct cable  
for iPod (CA-DC300N) is  
connected.

File indicator (Current file/All files)  
A number up to 999 is displayable.

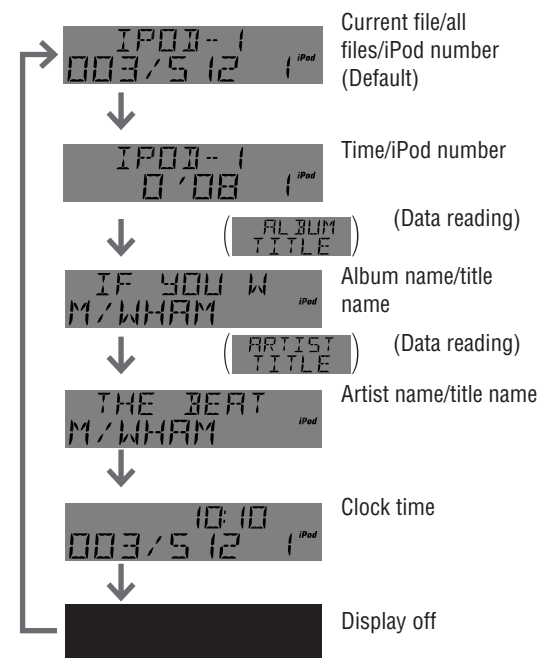

Press **[DISP]**.



#### Notes:

- To have another circle scroll while a text is displayed, press **[3]** (SCROLL). If the number of displayed characters is 8 or less, the characters do not scroll.
- "NO TEXT" is displayed when there is no information.
- The title may not be displayed correctly if it is longer than 250 alphanumeric characters.

### Repeat Play

The current file is repeated.  
Press **[6]** (REPEAT). **REP** lights.  
Press again to cancel.

**Note:** The All Repeat Play function of iPod is always activated and cannot be canceled from this unit.

### Shuffle

The shuffle function of iPod corresponds to the RANDOM function of this unit.

#### Songs

All the available files are played in a random sequence.  
Press **[4]** (RANDOM). **R▶** lights.  
Press again to cancel.

#### Albums

All the playable albums are played in a random sequence.  
Hold down **[4]** (RANDOM) for 2 sec. or more. **R▶** blinks.  
Hold down again to cancel.

#### Notes:

- The iPod equipped with a dock connector is exclusively connectable. Further information about the controllable iPod is described below.

#### Controllable iPod/software version

- 3rd generation iPod/ver. 2.3
- 4th generation iPod/ver. 3.1.1
- 5th generation iPod/ver. 1.2 (Video playback is not supported.)
- iPod photo/ver. 1.2.1
- iPod mini/ver. 1.4.1
- iPod nano/ver. 1.2

\* Operation check has been completed with software available at the end of September, 2006. We do not guarantee the operation with our future products or upgraded software.

- Please make sure to detach the iPod after turning off the car engine (turning the ACC to OFF). The iPod may not shut down while still connected, which may result in battery depletion.
- Please do not connect iPod accessories such as an iPod remote control or headphones while connected with the unit. The unit may not operate correctly.
- Connect this unit after turning down the volume of the iPod.
- "NO IPOD" appears until the iPod is recognized after connecting the iPod, turning on the power of the main unit, or performing source selection on the main unit side. This indicates there is nothing wrong with the main unit.
- We do not guarantee all the operations of connectable devices.



Connection of the optional direct cable for iPod (CA-DC300N) allows users to operate the iPod including file selection and file sequence change with the buttons on this unit.

- 1 Connect the iPod.
- 2 Press **[SOURCE]** to select the iPod mode. Playback starts.  
**Note:** If playback does not start, press **[BAND]** (▶||).
- 3 Select a desired portion.

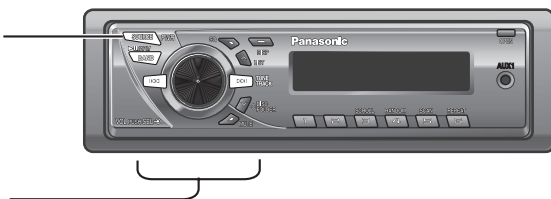

**File Selection**

**[▶▶]:** Next file  
**[◀◀]:** Beginning of the current file  
For the preceding file, press twice.

**Notes:**

- Hold down for fast forward/reverse.
- When fast forward comes to the end of a file or fast reverse comes to the beginning of a file, regular playback starts even if the fast forward or reverse button is pressed.

**Pause**

Press **[BAND]** (▶||).  
Press again to cancel.

- 1 Press **[^]** (LIST) to activate the Playing Mode Selection mode.
- 2 Turn **[VOL]** clockwise or counterclockwise to adjust.
- 3 Press **[VOL]** (PUSH SEL: Select) to determine the selection.
- 4 Turn **[VOL]** clockwise or counterclockwise to select a portion to be played.
- 5 Press **[VOL]** (PUSH SEL: Select) to determine the selection.

① PLAYLIST: Playback by playlist (Default)  
② ARTIST: Playback by artist  
ALBUM: Playback by album

**Notes:**

- To return to the regular mode, press **[DISP]**.
- Files without an album name or an artist name are not playable in the playing mode of the album or artist display respectively.

**Play Mode indicators**

Lights when each mode is activated.  
**REP** Repeat play  
**R▶** Shuffle play (songs)  
Blinks when each mode is activated.  
**R▶** Shuffle play (albums)

File indicator (Current file/All files)  
A number up to 999 is displayable.

Lights when the direct cable for iPod (CA-DC300N) is connected.



iPod number, 1 (iPod 1)/2 (iPod 2),  
Lights when the Expansion Module (CY-EM100N) is connected.

**Notes:**

- The iPod equipped with a dock connector is exclusively connectable. Further information about the controllable iPod is described below.

**Controllable iPod/software version**

- 3rd generation iPod/ver. 2.3
- 4th generation iPod/ver. 3.1.1
- 5th generation iPod/ver. 1.2 (Video playback is not supported.)
- iPod photo/ver. 1.2.1
- iPod mini/ver. 1.4.1
- iPod nano/ver. 1.2

\* Operation check has been completed with software available at the end of September, 2006. We do not guarantee the operation with our future products or upgraded software.

- Please make sure to detach the iPod after turning off the car engine (turning the ACC to OFF). The iPod may not shut down while still connected, which may result in battery depletion.
- Please do not connect iPod accessories such as an iPod remote control or headphones while connected with the unit. The unit may not operate correctly.
- Connect this unit after turning down the volume of the iPod.
- "NO IPOD" appears until the iPod is recognized after connecting the iPod, turning on the power of the main unit, or performing source selection on the main unit side. This indicates there is nothing wrong with the main unit.
- We do not guarantee all the operations of connectable devices.

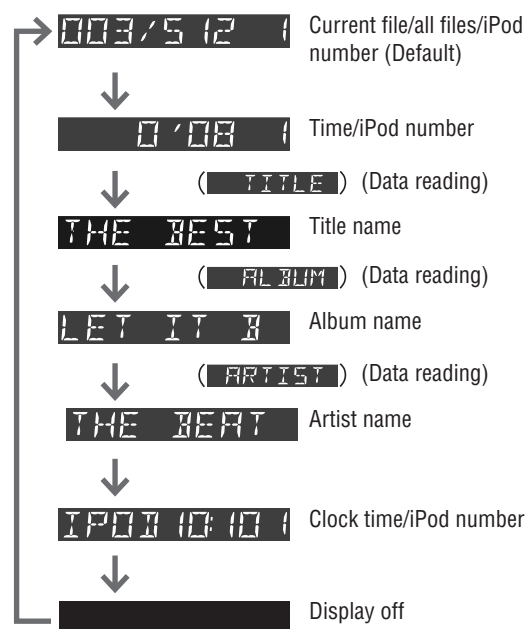

Press **[DISP]**.

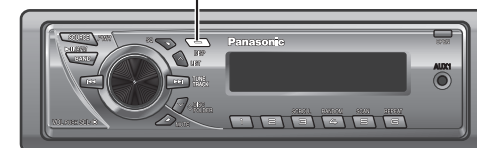

**Notes:**

- To have another circle scroll while a text is displayed, press **[3]** (SCROLL). If the number of displayed characters is 8 or less, the characters do not scroll.
- "NO TEXT" is displayed when there is no information.
- The title may not be displayed correctly if it is longer than 250 alphanumeric characters.

**Repeat Play**

The current file is repeated.  
Press **[6]** (REPEAT). **REP** lights.  
Press again to cancel.

**Note:** The All Repeat Play function of iPod is always activated and cannot be canceled from this unit.

**Shuffle**

The shuffle function of iPod corresponds to the RANDOM function of this unit.

**Songs**

All the available files are played in a random sequence.  
Press **[4]** (RANDOM). **R▶** lights.  
Press again to cancel.

**Albums**

All the playable albums are played in a random sequence.  
Hold down **[4]** (RANDOM) for 2 sec. or more. **R▶** blinks.  
Hold down again to cancel.

Be sure to read "Safety Information" in the Operating Instructions for the Hands-Free Phone System before use.

## Connecting Hands-Free Phone System

Connect the Hands-Free Phone System (CY-BT100N) and establish the pairing. Refer to the instruction manual for the Hands-Free Phone System for further information.

**Note:** This unit is designed **only for receiving calls**. It cannot send calls.

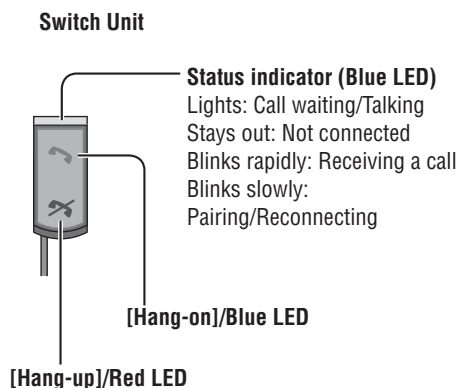

**1** Press **[Hang-on]** on the Hands-Free Phone System and pick up the phone.  
 The phone is in the incoming state.

**2** Adjust the volume if necessary.

**3** Press **[Hang-up]** on the Hands-Free Phone System and hung up the phone.

### Notes:

- "CONNECT" is displayed when information of the calling party cannot be acquired.
- To have another circle scroll while a telephone number is displayed, press **[3] (SCROLL)**. If the number of displayed characters is 8 or less, the characters do not scroll.

## Bluetooth Hands-Free Kit Mode

This mode is not selectable by pressing **[SOURCE]**, but activated by receiving an incoming call. (To pick up the phone, press **[Hang-on]** on the Bluetooth hands-free kit.)

- ① "HANDS-FREE" is scrolled when a call is coming in.
- ② The telephone number of the calling party is displayed.



### Notes:

- Only outline is described here. Refer to the operating instructions for the Hands-Free Phone System for further information.

- We do not guarantee all the operations of connectable devices.

## Adjust the Ring Volume

Turn **[VOL]** clockwise or counterclockwise to adjust the ring volume when a call is coming in.

- ①: Up
- ②: Down

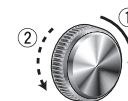

### Notes:

- The volume level adjusted here is linked to the talk volume.
- Depending on the model of a cellular phone, the ring tone comes from the main unit of the phone but may be inaudible. In that case, the volume cannot be adjusted during an incoming phone call.

## Reject Calls

Pressing **[Hang-up]** allows users to reject a call when the call is coming in.

## Bluetooth Disconnection/Reconnection

Pressing **[Hang-up]** allows users to temporarily disconnect when the phone is in the waiting state. Pressing **[Hang-on]** allows users to reconnect when the Bluetooth unit is temporarily disconnected.

**1** Press **[VOL] (PUSH SEL: Select)** to open the menu.



**2** Press **[VOL] (PUSH SEL: Select)** to select a mode to be adjusted.



**3** Turn **[VOL]** clockwise or counterclockwise to adjust.

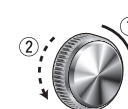

## Speaker Selection

(Setting range: LEFT, BOTH, RIGHT, default: BOTH)

- |   |           |                                    |
|---|-----------|------------------------------------|
| ① | SP LEFT:  | Sound from left speaker            |
| ② | SP BOTH:  | Sound from both speakers (Default) |
|   | SP RIGHT: | Sound from right speaker           |

### Notes:

- The volume can also be adjusted directly using **[VOL]** on the main unit. (→ Operating Instructions)
- To return to the regular mode, press **[DISP]**.
- If no operation takes place for more than 5 seconds in audio setting (2 seconds in the volume adjustment) the display returns to the regular mode.

## Volume Adjustment

(Setting range: 0 to 40, Default: 18)

### CQ-C5305W

- ①: Up
- ②: Down



### CQ-C3305W

- ①: Up
- ②: Down



### If You Suspect Something Wrong

Check and take steps as described below.

If the described suggestions do not solve the problem, it is recommended to take the unit to your nearest authorized Panasonic Service Center. The product should be serviced only by qualified personnel. Please refer the checking and the repair to professionals. Panasonic shall not be liable for any accidents arising out of neglect of checking the unit or your own repair after your checking.

**Never take measures especially those other than indicated by *italic* letters in "Possible solution" described below because those are too dangerous for users to handle themselves.**

### Warning

- Do not use the unit in an irregular condition, for example, without sound, or with smoke or a foul smell, which can cause ignition or electric shock. Immediately stop using the unit and consult your dealer.
- Never try to repair the unit by yourself because it is dangerous to do so.

Display	Possible cause → Possible solution
  (After 5 seconds) ↓ The next disc automatically	The disc is dirty or upside down. → <i>Check the disc.</i>  The disc has scratches. → <i>Eject the magazine.</i> <ul style="list-style-type: none"> <li>Check the disc.</li> <li>Load the disc again.</li> </ul>
	No operation by some cause. → <i>Eject the magazine. If failure persists, press the reset switch on the CD changer. If normal operation is not restored, consult your dealer or the nearest Panasonic Service Center to ask for repairs.</i>
	No disc is in the CD Changer (magazine). → <i>Insert discs into the CD changer (magazine).</i>
	The changer has become disconnected from the unit in the changer mode. → <i>Verify the wiring.</i>

**Note:** Messages in the action and display sections of the error chart vary with changer. Refer to the operating instructions for the CD changer for details.

Display	Possible cause → Possible solution
	The iPod cable was disconnected in the iPod mode. → <i>Reconnect the iPod cable.</i>
	Your iPod has no playable music. → <i>Download playable music to your iPod.</i>

### If You Suspect Something Wrong

Check and take steps as described below.

If the described suggestions do not solve the problem, it is recommended to take the unit to your nearest authorized Panasonic Service Center. The product should be serviced only by qualified personnel. Please refer the checking and the repair to professionals. Panasonic shall not be liable for any accidents arising out of neglect of checking the unit or your own repair after your checking.

**Never take measures especially those other than indicated by *italic* letters in "Possible solution" described below because those are too dangerous for users to handle themselves.**

### Warning

- Do not use the unit in an irregular condition, for example, without sound, or with smoke or a foul smell, which can cause ignition or electric shock. Immediately stop using the unit and consult your dealer.
- Never try to repair the unit by yourself because it is dangerous to do so.

Display	Possible cause → Possible solution
  (After 5 seconds) ↓ The next disc automatically	The disc is dirty or upside down. → <i>Check the disc.</i>  The disc has scratches. → <i>Eject the magazine.</i> <ul style="list-style-type: none"> <li>Check the disc.</li> <li>Load the disc again.</li> </ul>
	No operation by some cause. → <i>Eject the magazine. If failure persists, press the reset switch on the CD changer. If normal operation is not restored, consult your dealer or the nearest Panasonic Service Center to ask for repairs.</i>
	No disc is in the CD Changer (magazine). → <i>Insert discs into the CD changer (magazine).</i>
	The changer has become disconnected from the unit in the changer mode. → <i>Verify the wiring.</i>

**Note:** Messages in the action and display sections of the error chart vary with changer. Refer to the operating instructions for the CD changer for details.

Display	Possible cause → Possible solution
	The iPod cable was disconnected in the iPod mode. → <i>Reconnect the iPod cable.</i>
	Your iPod has no playable music. → <i>Download playable music to your iPod.</i>



**Matsushita Electric Industrial Co., Ltd.**  
Web Site: <http://panasonic.net>